



Better solutions through innovation



Owner's Manual

Model
BFSL33









IMPORTANT SAFETY INFORMATION: Always read this manual first before attempting to install or use this fireplace. For your safety, always comply with all warnings and safety instructions contained in this manual to prevent personal injury or property damage.

To view the full line of Dimplex products, please visit
www.dimplex.com

7211040100R02



Table of Contents

 Welcome & Congratulations	3
 IMPORTANT INSTRUCTIONS	4
 Fireplace Installation	6
 Operation	6
 Maintenance	10
 Accessories	10
 Warranty	11
 Replacement Parts	13

Always use a qualified technician or service agency to repair this fireplace.

! NOTE: Procedures and techniques that are considered important enough to emphasize.

⚠ CAUTION: Procedures and techniques which, if not carefully followed, will result in damage to the equipment.

⚠ WARNING: Procedures and techniques which, if not carefully followed, will expose the user to the risk of fire, serious injury, or death.

Welcome & Congratulations

Thank you and congratulations for choosing to purchase an electric fireplace from Dimplex, the world leader in electric fireplaces.

Please carefully read and save these instructions.

⚠ CAUTION: Read all instructions and warnings carefully before starting installation. Failure to follow these instructions may result in a possible electric shock, fire hazard and will void the warranty.

Please record your model and serial numbers below for future reference: model and serial numbers can be found on the Model and Serial Number Label of your fireplace.

Model Number _____ **Serial Number** _____

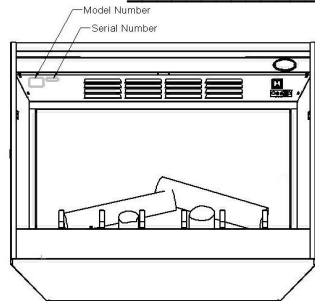
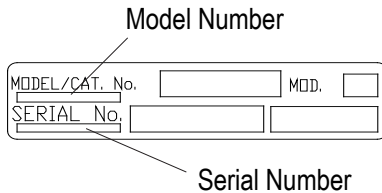

NO NEED TO RETURN TO THE STORE

Questions with operation or assembly? Require Parts Information?
Product Under Manufacturer's Warranty?

Contact us at:  www.dimplex.com/customer_support
For Troubleshooting and Technical Support

OR  **Toll-Free 1-888-DIMPLEX (1-888-346-7539)**
Monday to Friday 8:00 a.m. to 4:30 p.m. EST
Please have your model number and product serial number ready. (See above)

IMPORTANT INSTRUCTIONS

When using electrical appliances, basic precautions should always be followed to reduce the risk of fire, electric shock, and injury to persons, including the following:

- ① Read all instructions before using this appliance.
- ② This fireplace is hot when in use. To avoid burns, do not let bare skin touch hot surfaces. The trim around the heater outlet becomes hot during heater operation. Keep combustible materials, such as furniture, pillows, bedding, papers, clothes, and curtains at least 3 feet (0.9m) from the front of the unit.
- ③ Extreme caution is necessary when any heater is used by or near children or invalids and whenever the fireplace is left operating and unattended.
- ④ Do not operate any heater after it malfunctions. Disconnect power at the service panel and have the heater inspected by a reputable electrician before reusing.
- ⑤ Do not operate any unit with a damaged cord or plug, or if the heater has malfunctioned, or if the electric fireplace has been dropped or damaged in any manner, contact Dimplex Technical Service at 1-888-346-7539.
- ⑥ Never locate this heater where it may fall into a bathtub or other water container.
- ⑦ Do not use outdoors.
- ⑧ Do not insert or allow foreign objects to enter any ventilation or exhaust opening as this may cause an electric shock or fire, or damage to the heater.
- ⑨ To prevent a possible fire, do not block air intake or exhaust in any manner.
- ⑩ All electrical heaters have hot and arcing or sparking parts inside. Do not use in areas where gasoline, paint, or flammable liquids are used or stored.



CAUTION
RISK OF ELECTRIC SHOCK
DO NOT OPEN
NO USER-SERVICEABLE PARTS INSIDE



SAVE THESE INSTRUCTIONS

IMPORTANT INSTRUCTIONS

⑪ Do not modify this fireplace. Use it only as described in this manual. Any other use not recommended by the manufacturer may cause fire, electric shock or injury to persons.

⑫ Do not burn wood or other materials in this fireplace.

⑬ Do not strike fireplace glass.

⑭ Always use a certified electrician for installation.

⑮ Disconnect all power coming to fireplace at main service panel before performing any cleaning, or maintenance.

⑯ When transporting or storing the fireplace, keep in a dry place, free from excessive vibration and store as to avoid damage.

 **WARNING:** Remote control contains small batteries. Keep away from children. If swallowed, seek medical attention immediately.

 **WARNING:** Do not install battery backwards, charge, put in fire or mix with used or other battery types - may explode or leak causing injury.

! **NOTE:** Changes or modifications not expressly approved by the party responsible for compliance could void user's authority to operate the equipment.

 **CAUTION:** This equipment has been tested and found to comply with the limits for Class B digital device, pursuant to part 15 of the FCC Rules. These limits are designed to provide reasonable protection against harmful interference in a residential installation. This equipment generates, uses and can radiate radio frequency energy and, if not installed and used in accordance with the instructions, may cause harmful interference to radio or television reception, which can be determined by turning the equipment off and on, the user is encouraged to try to correct the interference by one or more of the following measures:

- Reorient or relocate the receiving antenna.
- Increase the separation between the equipment and the receiver.
- Connect the equipment into an outlet on a circuit different from that to which the receiver is connected.
- Consult the dealer or an experienced radio/TV technician for help.

Operation is subject to the following two conditions: (1) this device may not cause interference and (2) this device must accept any interference, including interference that may cause undesired operation of the device.

Fireplace Installation

Bathroom Installation

This firebox must be protected by a GFI circuit.

To prevent electrical shock this unit is an electrical appliance that is not watertight and must be installed as to prevent water from

entering the unit. This unit must be installed away from showers, tubs, etc. Never locate fireplace where it may fall into a bathtub or other water containers. Keep towels and other combustible materials 3 feet (0.9 m) away from the front of the unit.

Operation

Figure 1

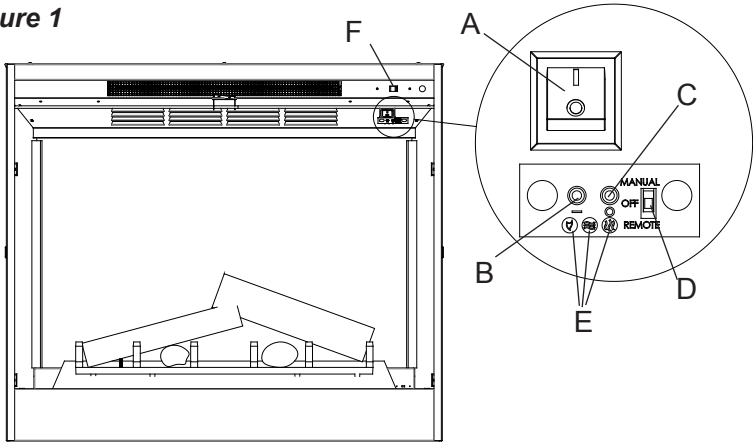

⚠ WARNING: This electric firebox must be properly installed before it is used.

Manual Controls

The controls for the Electric Fireplace are located at the bottom right hand corner of the unit.

⚠ CAUTION: Ensure that the Voltage Selector switch is set to the appropriate voltage (115V or 230V) (Figure 1F)

A. On/Off Switch

The on/off switch energizes the firebox.

Operation

B. "--" Button

Pressing this button toggles sequentially through the three levels of the fireplace: flame only; to flame and low heat; to flame and high heat.

! NOTE: After the unit is switched from flame and high heat to another function there is a 30 second fan delay, where the fan will continue running before turning off.

C. "O" Button

Pressing this button at any time will shut the unit off.



D. 3-Position Switch

Switches the operation of the fireplace between the different modes of the fireplace:

- OFF (center): Makes the unit inoperable.
- MANUAL (top): All functions of the fireplace are controlled by the On and Off buttons as described above (B, C).
- REMOTE (bottom): All functions of the fireplace are controlled by the Remote Control.

E. LED Indicators

Depicts which of the three levels the fireplace is currently operating

at: Level 1 , Level 2  or Level 3 .

F. Voltage Selector Switch

Needs to be set to reflect the incoming voltage to the unit - 115V or 230V.

! NOTE: The heater may emit a slight, harmless odor when first used. This odor is a normal condition caused by initial heating of internal heater parts and will not occur again.

Resetting the Temperature Cutoff Switch

Should the heater overheat, an automatic cut out will turn the fireplace off and it will not come back on without being reset. It can be reset by switching the On/Off Switch to Off and waiting ten minutes before switching the unit back on.

⚠ CAUTION: If you need to continuously reset the heater, disconnect power and call Dimplex customer service at 1-888-DIMPLEX (1-888-346-7539).

Remote Control

The fireplace is supplied with a radio frequency remote control.

Operation

Figure 2

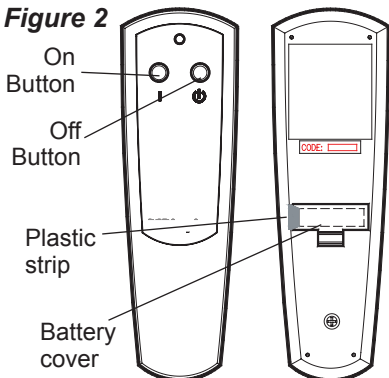

This remote control has a range of approximately 50 feet (15.25 m), it does not have to be pointed at the fireplace and can pass through most obstacles (including walls). It is supplied with one of hundreds of independent frequencies to prevent interference with other units.

! NOTE: Before attempting any operation with the remote, pull the plastic insulator strip out from between the remote casing and battery cover (Figure 2).

Remote Control Initialization/ Reprogramming

If the Remote Control or Remote Control Receiver has been replaced, follow these steps to initialize the Remote Control and Receiver:

1. Ensure that power is supplied through main service panel.
2. Access the manual controls, (remove the glass doors if applicable) pull the right hand steel curtain to the outside of the unit.
3. Locate manual controls. (Figure 1)
4. Set the 3-Position switch to "Remote" (Figure 1D)
5. Activate the On/Off switch, the red Level 1 Indicator Light will flash. (Figure 1A)
6. Press and hold the On button on the manual controls (Figure 1B) for five seconds. The Level 1 Indicator Light (Figure 1E) will then flash for 10 seconds.
7. **Within** the 10 seconds press the ON button located on the remote control. (Figure 2)

This will synchronize the remote control and receiver.

Battery Replacement

To replace the battery:

1. Slide battery cover open on the remote control (Figure 2).
2. Install one (1) 12-Volt (A23) battery in the battery holder.

Operation

3. Close the battery cover.



Battery must be recycled or disposed of properly.

Check with your Local Authority or Retailer for recycling advice in your area.

Wall Mounted Controls

The fireplace can be installed with wall mounted controls. These controls include wall switches, thermostats or wall mounted remote controls. (See installation guide for detailed instructions.)

1. Wall Mounted Switches

This model may be installed so that a wall mounted switch energizes the firebox and dependent on the wiring can control the operation/function of the flame and heat (On/Off Switch must be in the ON position). For all wiring and control options see the Installation Guide.

2. Wall Mounted Thermostat

This unit may be installed so that a wall mounted thermostat can adjust the heat temperature to your individual requirements. Please refer to thermostat manufacturers operation Instructions.

3. Wall Mounted Remote Controls (WRCPF-KIT)

Dimplex manufactures a optional wall mounted remote control which allows the user to fully control the fireplace from a central location with the added functionality of a built in thermostat.



Maintenance

⚠ WARNING: Disconnect all power coming to fireplace at main service panel before attempting maintenance or cleaning to reduce risk of fire, shock or damage to persons.

Partially Reflective Glass Cleaning

The partially reflective glass is cleaned in the factory during the assembly operation. During shipment, installation, handling, etc., the partially reflective glass surface may collect dust particles. These can be removed by buffing lightly with a clean dry cloth.

To remove fingerprints or other marks, the partially reflective glass can be cleaned with a damp cloth using high quality household glass cleaner. The partially reflective glass should be com-

pletely dried with a lint free cloth. To prevent scratching, do not use abrasive cleaners or spray liquids on any surface.

Fireplace Surface Cleaning

Use warm water only to clean painted surfaces of the Compact Fireplace. Do not use abrasive cleaners.

Servicing

Except for light bulb replacement and cleaning described above, an authorized service representative should perform any other servicing.



Accessories

Please contact your local dealer for genuine Dimplex accessories. Example: glass door kits, wall mount control kits, plug kits, and cabinets designed to fit your fireplace.



Two Year Limited Warranty

Products to which this limited warranty applies

This limited warranty applies to model BFSL33 and to newly purchased Dimplex fireplace surrounds (mantels) and trims. This limited warranty applies only to purchases made in any province of Canada except for Yukon Territory, Nunavut, or Northwest Territories or in any of the 50 States of the USA (and the District of Columbia) except for Hawaii and Alaska. This limited warranty applies to the original purchaser of the product only and is not transferable.

Products excluded from this limited warranty

Light bulbs are not covered by this limited warranty and are the sole responsibility of the owner/purchaser. Products purchased in Yukon Territory, Nunavut, Northwest Territories, Hawaii, or Alaska are not covered by this limited warranty. Products purchased in these States, provinces, or territories are sold AS IS without warranty or condition of any kind (including, without limitation, any implied warranties or conditions of merchantability or fitness for a particular purpose) and the entire risk of as to the quality and performance of the products is with the purchaser, and in the event of a defect the purchaser assumes the entire cost of all necessary servicing or repair.

What this limited warranty covers and for how long

Products, other than fireplace surrounds (mantels) and trims, covered by this limited warranty have been tested and inspected prior to shipment and, subject to the provisions of this warranty, Dimplex warrants such products to be free from defects in material and workmanship for a period of 2 years from the date of the first purchase of such products.

Dimplex fireplace surrounds (mantels) and trims covered by this limited warranty have

been tested and inspected prior to shipment and, subject to the provisions of this warranty, Dimplex warrants such products to be free from defects in material and workmanship for a period of 1 year from the date of first purchase of such products.

The limited 2 year warranty period for products other than fireplace surrounds (mantels) and trims and the limited 1 year warranty period for fireplace surrounds (mantels) and trims also applies to any implied warranties that may exist under applicable law. Some jurisdictions do not allow limitations on how long an implied warranty lasts, so the above limitation may not apply to the purchaser.

What this limited warranty does not cover

This limited warranty does not apply to products that have been repaired (except by Dimplex or its authorized service representatives) or otherwise altered. This limited warranty does further not apply to defects resulting from misuse, abuse, accident, neglect, incorrect installation, improper maintenance or handling, or operation with an incorrect power source.

What you must do to get service under this limited warranty

Defects must be brought to the attention of Dimplex Technical Service by contacting Dimplex at 1-888-DIMPLEX (1-888-346-7539), or 1367 Industrial Road, Cambridge Ontario, Canada N1R 7G8. Please have proof of purchase, catalogue/model and serial numbers available when calling. Limited warranty service requires a proof of purchase of the product.

What Dimplex will do in the event of a defect

In the event a product or part covered by this limited warranty is proven to be defective in material or workmanship during (i) the 2 year limited warranty period for products other than fireplace surrounds (mantels) and trims, and (ii) the 1 year limited warranty period for surrounds (mantels) and trims, you have the following rights:

Warranty

- Dimplex will in its sole discretion either repair or replace such defective product or part without charge. If Dimplex is unable to repair or replace such product or part, or if repair or replacement is not commercially practicable or cannot be timely made, Dimplex may, in lieu of repair or replacement, choose to refund the purchase price for such product or part.
- Limited warranty service will be performed solely by dealers or service agents of Dimplex authorized to provide limited warranty services.
- **For products other than surrounds (mantels) and trims**, this 2 year limited warranty entitles the purchaser to on-site or in-home warranty services. Accordingly, Dimplex will be responsible for all labour and transportation associated with repairing or replacing the product or part except as follows: (i) charges which may be levied for travel costs incurred to travel to the purchaser's site where the product is located if the purchaser's site is beyond 30 miles (48 km) from the closest service depot of Dimplex's dealer or service agent; and (ii) the purchaser is solely responsible for providing clear access to all serviceable parts of the product.
- **For surrounds (mantels) and trims**, this 1 year limited warranty does not entitle the purchaser to on-site or in-house warranty services. The purchaser is responsible for removal and transportation of the surrounds (mantels) and trims (and any repaired or replacement product or part) to and from the authorized dealer's or service agent's place of business. On-site or in-home services for surrounds (mantels) and trims may be performed at the purchaser's specific request and expense at Dimplex's then-current rates for such services. Dimplex will not be responsible for, and this limited warranty shall not include, any expense incurred for installation or removal of the surrounds

(mantels) or trims or any part thereof (or any replacement product or part) including, without limitation, all shipping costs and transportation costs to and from the authorized dealer's or service agent's place of business and all labour costs. Such costs shall be the purchaser's responsibility.

What Dimplex and its dealers and service agents are also not responsible for:

IN NO EVENT WILL DIMPLEX, OR ITS DIRECTORS, OFFICERS, OR AGENTS, BE LIABLE TO THE PURCHASER OR ANY THIRD PARTY, WHETHER IN CONTRACT, IN TORT, OR ON ANY OTHER BASIS, FOR ANY INDIRECT, SPECIAL, PUNITIVE, EXEMPLARY, CONSEQUENTIAL, OR INCIDENTAL LOSS, COST, OR DAMAGE ARISING OUT OF OR IN CONNECTION WITH THE SALE, MAINTENANCE, USE, OR INABILITY TO USE THE PRODUCT, EVEN IF DIMPLEX OR ITS DIRECTORS, OFFICERS, OR AGENTS HAVE BEEN ADVISED OF THE POSSIBILITY OF SUCH LOSSES, COSTS OR DAMAGES, OR IF SUCH LOSSES, COSTS, OR DAMAGES ARE FORESEEABLE. IN NO EVENT WILL DIMPLEX, OR ITS OFFICERS, DIRECTORS, OR AGENTS BE LIABLE FOR ANY DIRECT LOSSES, COSTS, OR DAMAGES THAT EXCEED THE PURCHASE PRICE OF THE PRODUCT.

SOME JURISDICTIONS DO NOT ALLOW THE EXCLUSION OR LIMITATION OF INCIDENTAL OR CONSEQUENTIAL DAMAGES, SO THE ABOVE LIMITATION OR EXCLUSION MAY NOT APPLY TO THE PURCHASER.

How State and Provincial law apply

This limited warranty gives you specific legal rights, and you may also have other rights which vary from jurisdiction to jurisdiction. The provisions of the United Nations Convention on Contracts for the Sale of Goods shall not apply to this limited warranty or the sale of products covered by this limited warranty.



Replacement Parts

Log Set Assembly	0439560100RP
Flicker Motor	2000210100RP
Blower Assembly	5300110300RP
Heater Elements	2203460100RP
Cutout	2300201100RP
On/Off Switch	2800070400RP
Remote Control Switchboard	3000820800RP
Capacitor	2300030100RP
3 LED Strip	3000850100RP
Flicker Rod	5902070100RP
Partially Reflective Glass	5900161600RP
Remote Control	3000370600RP
Remote Control Receiver	3000820700RP
LED Driver Board	3000810300RP
Log Driver Board	3000390100RP
Steel Curtain	8800240703RP
Steel Curtain Rod	8800250300RP
Bushing for Flicker Rod	8500000400RP
Voltage Selector Switch	2800080100RP
Top Trim Flange	1020660159RP
Left Side Trim Flange	1020650159RP
Right Side Trim Flange	1020650259RP
Pin Kit for Glass Accessory	9600470100RP



Dimplex North America Limited
1367 Industrial Road
Cambridge ON
Canada N1R 7G8

© 2013 Dimplex North America Limited